

Building Cladding Systems

- Architectural cladding systems
- Thermo-insulating roof and wall panels
- Cold rooms and clean rooms panels
- Pre-finished metal insulating panels for controlled environment rooms
- Natural lighting systems



CORE

ELASTRON
STEEL SERVICE CENTERS

About us

Under the new product's brand name CORE, ELASTRON S.A. successfully continues the production and distribution of well known and distinct for their quality, the composite insulating polyurethane panels, **ECOPANEL®**, for the construction industry including roof and wall cladding solutions (for industrial, commercial, distribution and agricultural buildings).

Our acquired experience in providing the Greek and European construction industry with value cladding solutions is based on three basic principles:

- Producing competitive and quality advanced building materials.
- Supporting and advising Designers, Specialists and Constructors from the design stage through to site installation.
- Supplying all our products rapidly and safely to any project.

The factors, which differentiate the quality of our products and the service we provide, are:

- Fully automatic production unit fulfills all the new requirements of modern composite materials.
- Stringent specifications of the panel's components.
- **ECOPANEL®**'s polyurethane core is CFC Free and HCFC free. Our company was the first in using current technology of harmless blowing agents.
- **ECOPANEL®** are designed to comply with European Building Regulations and Standards.
- Technical manuals are provided for Building Designers and full assistance to the Constructors.
- A Customer Service Department, which co-ordinates the safe and timely delivery of products at the work site.

The range of our company's products includes:

- Insulating composite panels for roof applications: **ECOPANEL®** type **RL**
- Insulating composite panels for wall cladding: **ECOPANEL®** type **WL** and for architectural wall cladding (concealed fix joint): **ECOPANEL®** type **WLC**
- Insulating composite panel for cold-storage rooms: **ECOPANEL®** type **FL**
- Insulating composite panel for farming facilities: **AGROPANEL** type **RL**
- Ancillary products (ridge, eave, valley gutter, louvers, drip flashing, verges etc.)

In addition we supply the construction market with a whole range of fasteners, fillers, sealants and roof-light solution in order to complement the insulated roof and wall cladding solutions.

Our technical department provides advisory service to all customers if necessary. For modern architectural cladding solutions, ELASTRON S.A. is the company to contact.

- BUILDING YOUR TOMORROW -

ECOPANEL® FL (cold room panel)

THICKNESS (D)

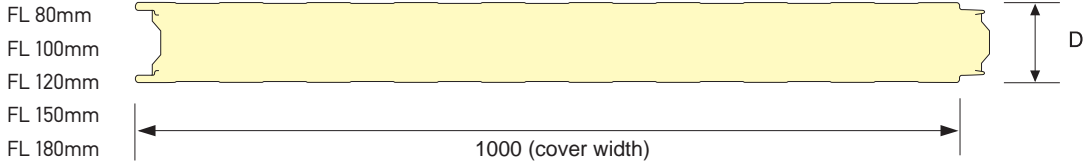

Special features

- ① Almost zero gap external joints suitable for highest standards of cleanliness in controlled environments.
- ② Special shaping internal joints for high performance of jointing sealability.
- ③ Removable before installation paper strips in both sides of joint for a better foam contact.
- ④ Polyurethane foam core CFC Free & HCFC Free. Harmless to the environment and safest for the ozone layer.
- ⑤ Steel sheet shape slightly corrugated or flat in both sides, suitable for food processing rooms.

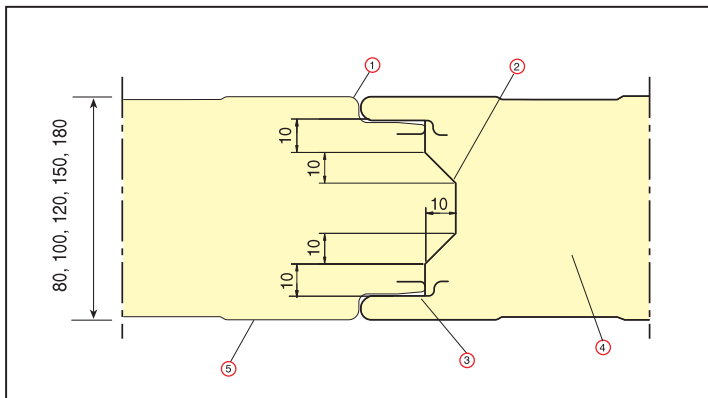

Product technical characteristics

PANEL TYPE	SHEET THICKNESS (mm)		CORE THICKNESS (mm)	WEIGHT (kg/m ²)	HEAT TRANSMISSION COEFFICIENT U (W/m ² K)	MAX LENGTH (m)
	OUTER	INNER				
FL 80	0,45	0,45	80	8,99	0,26	16,0
FL 100	0,45	0,45	100	10,89	0,21	
FL 120	0,45	0,45	120	11,65	0,18	
FL 150	0,45	0,45	150	12,79	0,14	
FL 180	0,45	0,45	180	13,93	0,12	

Thermal conductivity "λ" = 0.02 W/m*K

Panel tolerances

CUTTING LENGTH: ± 5~10mm (in relation to panel's length)

COVER WIDTH: ± 2mm

THICKNESS: ± 2mm (D < 100mm) / 2% (D > 100)

END SQUARE: 6%

Coatings

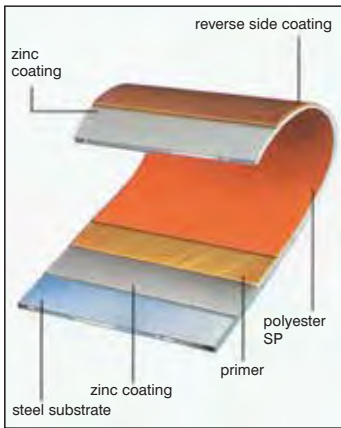

Polyester (SP)

- > Anti-corrosion protection
- > Inexpensive top coating suitable for normal environmental conditions
- > Total coating thickness 25µm

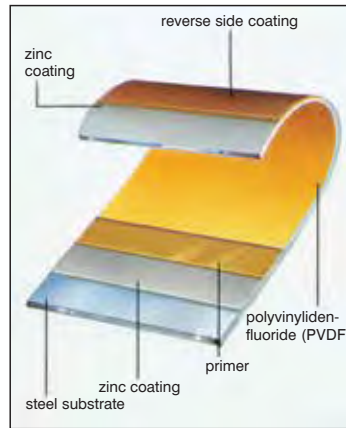

Polyvinylidene - Fluoride (PVDF)

- > High anti-corrosion protection
- > High UV rays protection
- > Total coating thickness 25µm ~ 50µm

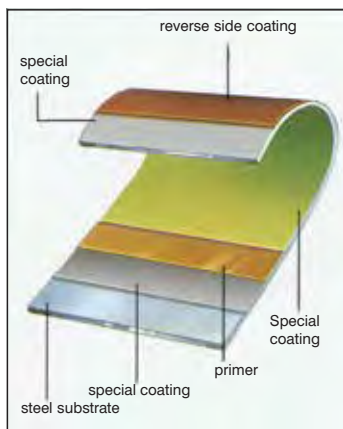

Special Coatings

- > Special coatings under request
- > Higher anti-corrosion protection
- > Higher UV rays protection
- > Total coating thickness 35µm ~ 60µm

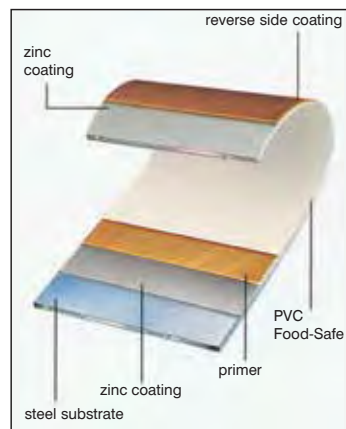

PVC Food-Safe

- > For controlled atmosphere rooms, food procession rooms and laboratories
- > Non toxic, chemical free surface, anti-bacterial
- > Only for internal use (not exposed to UV radiation)
- > Total coating thickness 110µm ~ 120µm

Technical specifications

METAL SHEET (ECOPANEL® - external AGROPANEL RL)

STANDARD TYPE: Hot dipped galvanized steel DX51D / S220GD ~ S320GD (EN 10346)

ANTI-CORROSION PROTECTION:
Zinc coating Z100 (100gr/m² ~ Z275 (275gr/m²) (EN 10346)

STANDARD COATINGS:

- Polyester (SP) - total thickness 25µm (EN 10169)
- PVC Food-Safe - non toxic anti-bacterial for internal use only (EN 10169)

ALTERNATIVE COATINGS:

Polyvinylidene-Fluoride (PVDF) / Special Coatings (under request)

INTERNAL SIDE OF AGROPANEL RL: Glass forced polyester (GRP) flat sheet, white, 0.60mm thick

POLYURETHANE FOAM (PUR) / POLYISOCUANURATE (PIR) PHYSICAL PROPERTIES:

Has no smell, chemically neutral, mould free, non deleterious CFC free, HCFC free, safe for the environment

SWELLING OF CORE: Through blowing agents safe for the environment and ozone layer (CFC Free & HCFC Free)

THERMO-INSULATING ECOPANEL®:

Produced according to EN 14509:2013
CE marked

CORE DENSITY: 40 ± 2 Kgr/m³

FOAM TYPE: PUR & PIR

FIRE CLASS: B-s2/s3,d0 - EN 13501-1

FIRE RESISTANCE: REI-30 / EI-30
EN 13501-2 (for thickness ≥ 80mm)

Flashings

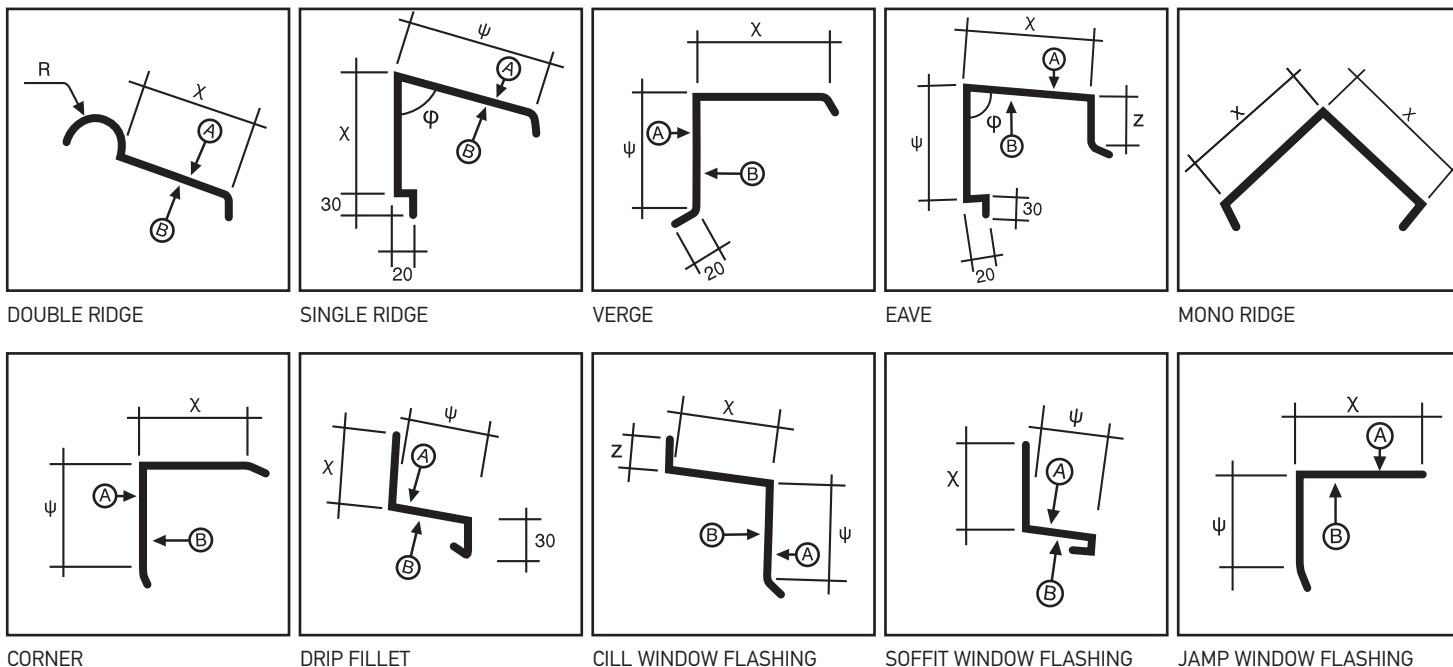

A wide range of flashing in different shapes, thickness and dimension are available under request.

Fasteners - Roof-lights - Fillers - Sealants

PRODUCT CATEGORIES

GRP Acrylic sheet



Sealant and fillers



Fasteners

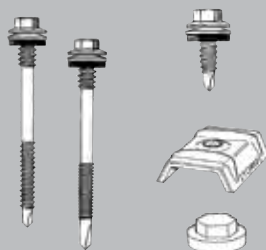

Color palette (RAL range)



The colors refer to steel sheets with Polyester (SP) coating and in stock. For other coating and other color range please contact the technical department.